

TÜRTECHNIK | DOOR TECHNOLOGY

GS VTS 73x 20x12

DE	Standard-Gleitschiene für 1-flügelige Türen	
	Montageanleitung.....	SEITE 2
EN	Standard slide rail for 1-leaf doors	
	Assembly instructions	PAGE 3
FR	Glissière standard pour portes à 1 vantail	
	Notice de montage	PAGE 4
ES	Guía deslizante estándar para puertas de 1 hoja	
	Instrucciones de montaje.....	PÁGINA 5

GS VTS 73x 20x12

Standard-Gleitschiene für 1-flügelige Türen | Standard slide rail for 1-leaf doors



Inhaltsverzeichnis

1. Begriffsdefinitionen / - abkürzungen.....	Seite	2
2. Komponenten und Zubehör	Seite	6
3. Montieren und Einstellen.....	Seite	8

1. Begriffsdefinitionen / - abkürzungen

AP	Anschraubplatte
AV	Achsverlängerung
F	geprüft nach EN 1154 und einsetzbar an Feuer- und Rauchschutztür
FE	Feststellung, elektromechanisch
FM	Feststellung, mechanisch
GS	Gleitschiene
MZ	Montagezubehör
ÖB	Öffnungsbegrenzung
ÖD/BC	Öffnungsdämpfung / Backcheck
VTS	Verdeckt liegender Türschließer
RSM	Rauchschtmodul
SRI	Schließfolgeregler, integriert
SW	Schlüsselweite



Bei Einsatz an Feuer- und Rauchschutztüren sind die Einbauanleitungen des Herstellers sowie die EN 1154 zu beachten!

VTS 735 +
GS VTS 73x 20x12

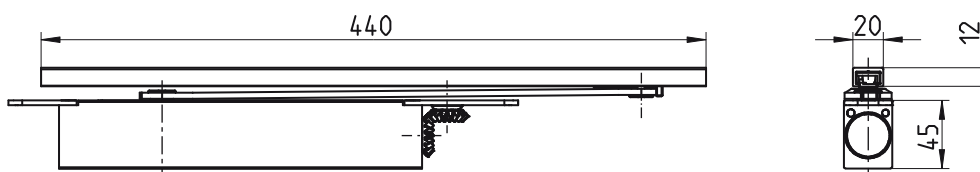

Originalanleitung

Bitte geben Sie das Dokument an den Benutzer weiter!

Table of contents

1. Definitions of terms/abbreviations.....	Page	3
2. Components and accessories	Page	6
3. Installing and adjusting	Page	8

1. Definitions of terms/abbreviations

AP	(„Anschraubplatte“)	fixing plate
AV	(„Achsverlängerung“)	axle extension
F		Tested to EN 1154 and used for fire and smoke protection doors
FE	(„Feststellung, elektromechanisch“)	hold-open, electromechanical
FM	(„Feststellung, mechanisch“)	hold-open, mechanical
GS	(„Gleitschiene“)	slide rail
MZ	(„Montagezubehör“)	fixing accessories
ÖB	(„Öffnungsbegrenzung“)	opening restriction
ÖD/BC	(„Öffnungsdämpfung / Backcheck“)	backcheck
VTS	(„Verdeckt liegender Türschließer“)	concealed door closer
RSM	(„Rauchschaltmodul“)	smoke switch module
SRI	(„Schließfolgeregler, integriert“)	door leaf coordinator, integrated
SW	(„Schlüsselweite“)	size



When using the door closer on fire and smoke protection doors, the installation instructions of the manufacturer and those set out in EN 1154 must be observed!

VTS 735 +
GS VTS 73x 20x12

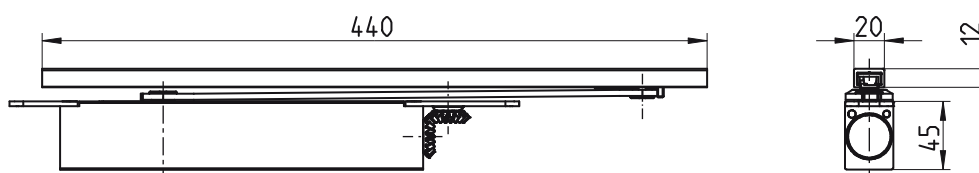

Translation of the original instructions

Please pass the document on to the user

GS VTS 73x 20x12

Glissière standard pour portes à 1 vantail | Guía deslizante estándar para puertas de 1 hoja



Table des matières

1. Définitions des termes et abréviations.....	Page	4
2. Composants et accessoires	Page	6
3. Montage et réglage	Page	8

1. Définitions des termes et abréviations

AP	Plaque à visser
AV	Rallonge d'axe
F	Certifié selon EN 1154 et utilisable sur portes coupe-feu et pare-fumée
FE	Dispositif d'arrêt électromécanique
FM	Dispositif d'arrêt mécanique
GS	Glissière
MZ	Accessoires de montage
ÖB	Limiteur d'ouverture
ÖD/BC	Freinage à l'ouverture / Backcheck
VTS	Ferme-porte encastré
RSM	Détecteur de fumée
SRI	Sélecteur de fermeture, intégré
SW	Ouverture de clé, surplat



En cas d'utilisation sur portes coupe-feu et pare-fumée, les instructions de montage du fabricant ainsi que la norme EN 1154 doivent être respectées!

VTS 735 +
GS VTS 73x 20x12

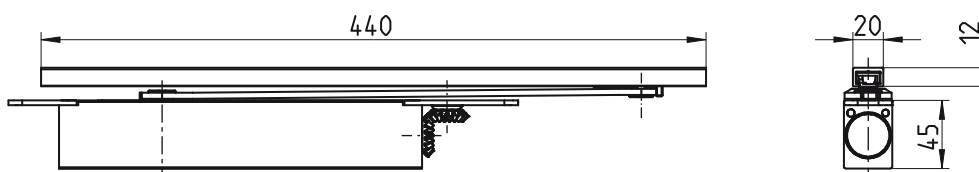

Traduction de la notice d'origine
Veuillez transmettre ce document à l'utilisateur !

Índice de contenido

1. Definiciones/abreviaturas de los términos.....	Página	5
2. Componentes y accesorios.....	Página	6
3. Montaje y ajuste	Página	8

1. Definiciones/abreviaturas de los términos

AP	Placa atornillada
AV	Prolongación del eje
F	Probado conforme a EN 1154 y aplicable en puertas cortafuegos y cortahumos
FE	Dispositivo de retención de apertura electromecánico
FM	Dispositivo de retención de apertura mecánico
GS	Guía deslizante
MZ	Accesorios de montaje
ÖB	Limitación de apertura
ÖD/BC	Frenado a la apertura/backcheck
VTS	Cierrapuertas oculto
RSM	Avisador de humos
SRI	Coordinador de cierre, integrado
SW	Tamaño



PRECAUCIÓN

¡En caso de aplicación en puertas cortafuegos y cortahumos se deberán observar las instrucciones de montaje del fabricante así como la EN 1154!

VTS 735 +
GS VTS 73x 20x12

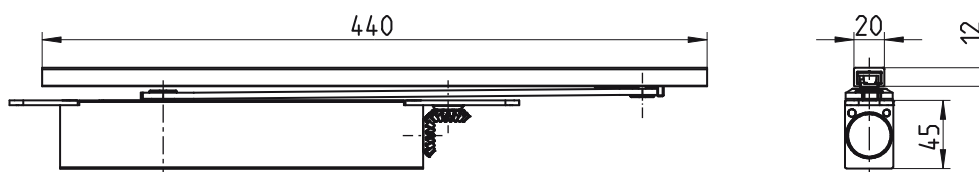

Traducción de las instrucciones originales

¡Entregue este documento al usuario!



2. Komponenten und Zubehör Components and accessories Composants et accessoires Componentes y accesorios

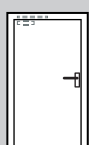

GS

■ **GS VTS 73x 20x12** K-18759-00-0

FM / ÖB GS

Option: ■ FM-VTS 73x 20x12 K-18981-00-0
 ■ ÖB-VTS 73x 20x12 K-19201-00-0
 ■ MZ GS VTS 73x 20x12 K-18766-00-0

FM-VTS 73x 20x12

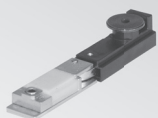

K-18981-00-0

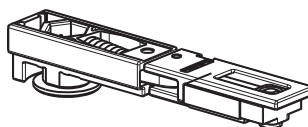

ÖB-VTS 73x 20x12



K-19201-00-0

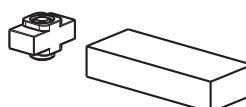

MZ GS VTS 73x 20x12



K-18766-00-0

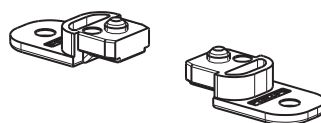



2x M5x20 

VTS

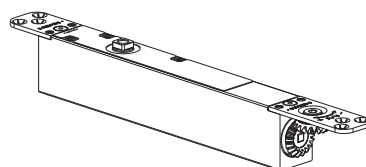

VTS 735 K-18756-00-0
 VTS 735/4 K-19453-00-0





6x M5x20 
 6x 5x40 

AP-VTS 73x

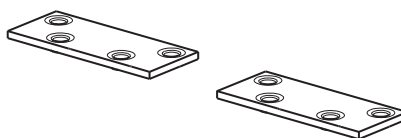

K-18558-00-0





4x M5x20 

AV-VTS 73x



6 mm K-18767-06-0
 8 mm K-18767-08-0



1x M6x25 
 1x M6x30 



3. Montieren und Einstellen Installing and adjusting Montage et réglage Montaje y ajuste

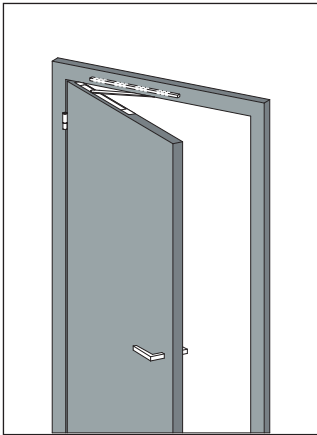

GS VTS 73x 20x12
K-18759

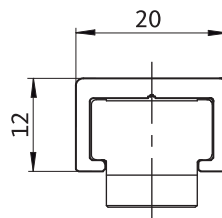
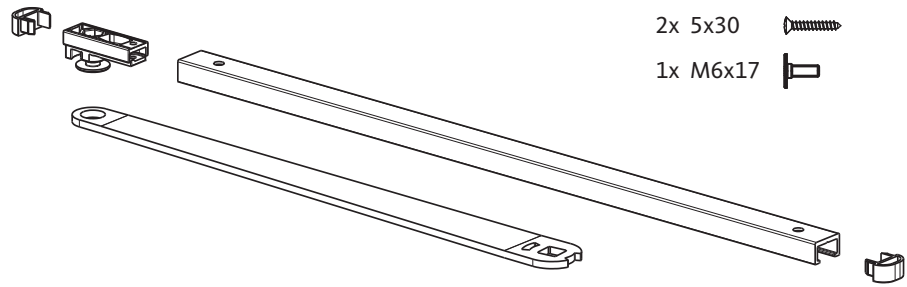

1a

Profil
Profile
Profil
Perfil

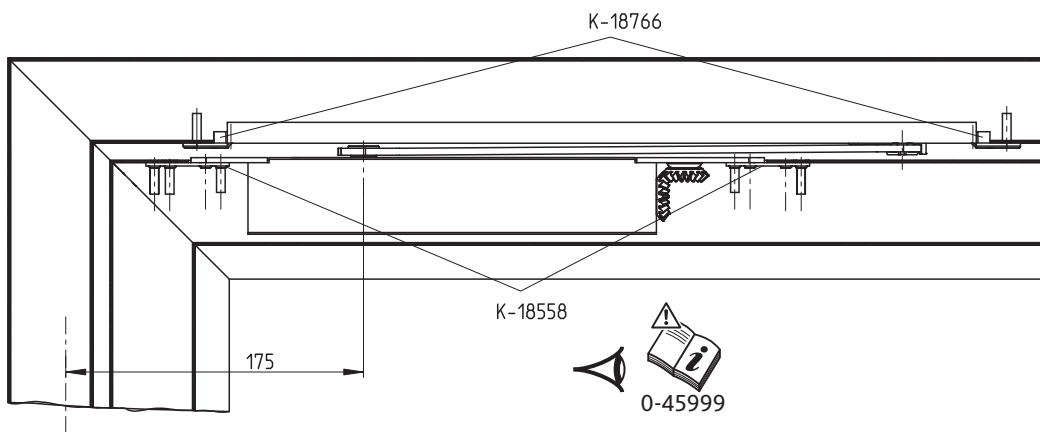
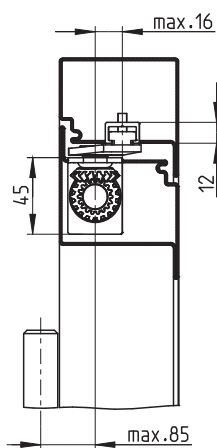
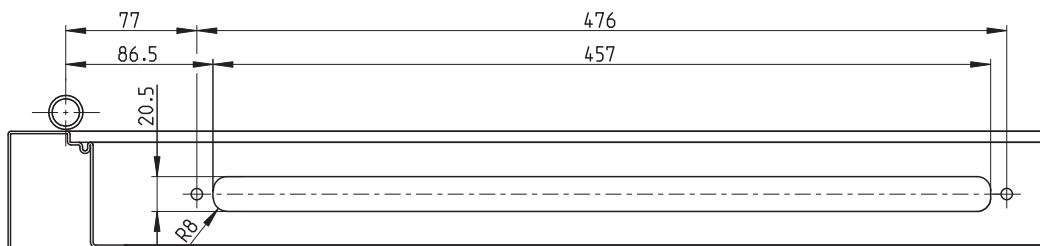

1b

Holz
Timber
Bois
Madera

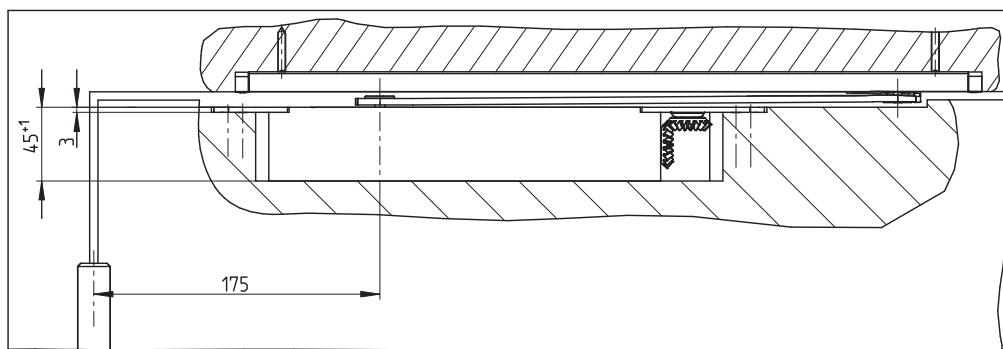
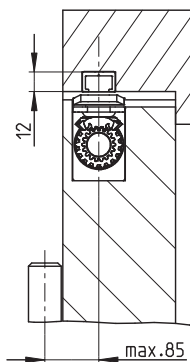
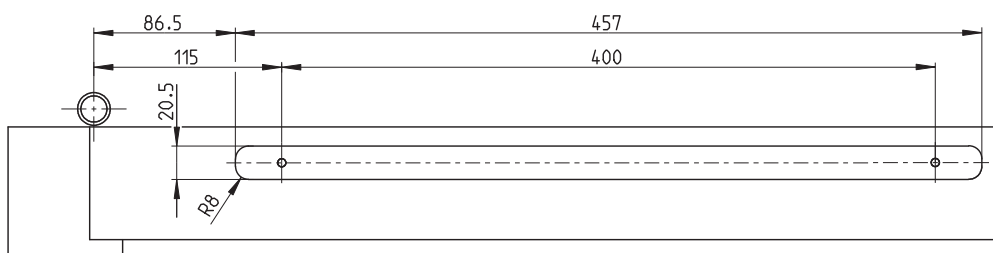



2

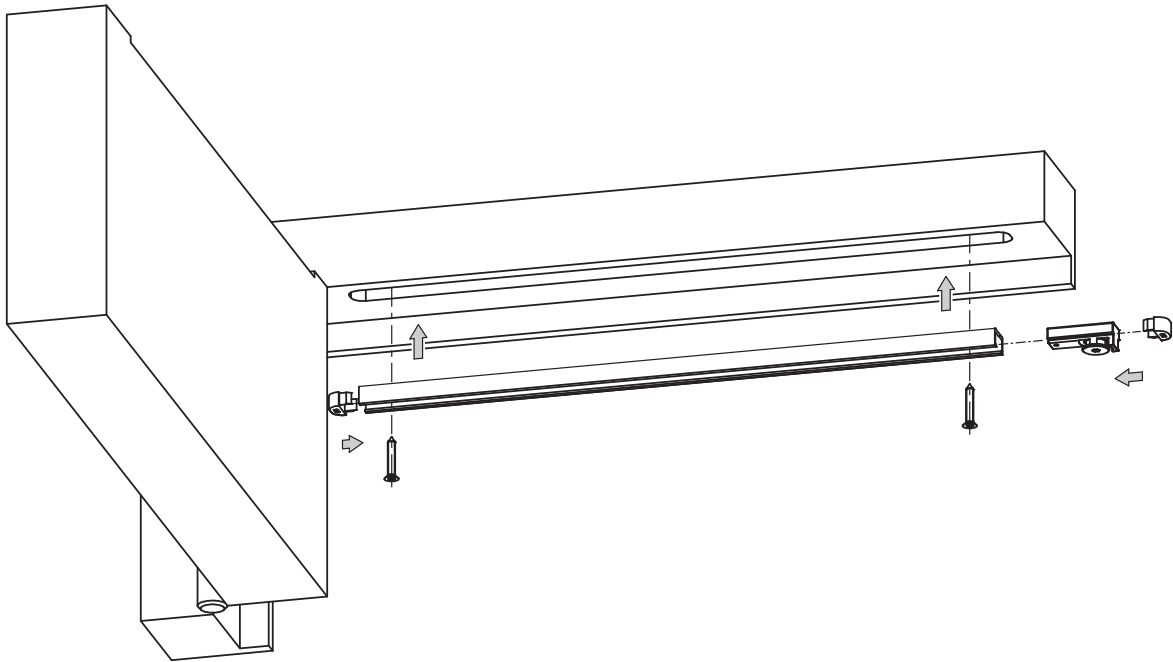

3

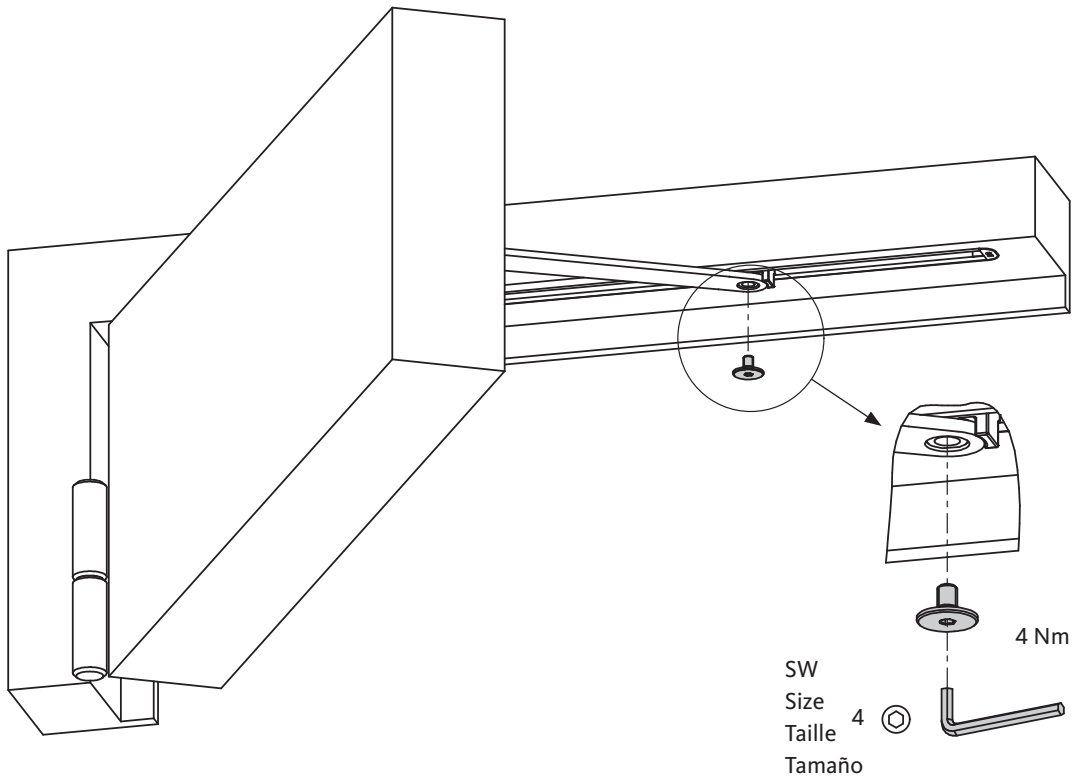

Notizen | Notes | Notes | Notas



Herausgeber | Editor:
Gretsch-Unitas GmbH
Baubeschläge
Johann-Maus-Str. 3
D-71254 Ditzingen
Tel. +49(0)7156 301-0
Fax +49(0)7156 301-293

www.g-u.com

Fehler, Irrtümer und technische Änderungen vorbehalten.
Errors and omissions reserved. Subject to technical modifications.
Sous réserve d'erreurs et de modifications techniques.
Reservado el derecho a realizar modificaciones técnicas. Salvo error u omisión.

Vorsprung mit System
Securing technology for you

